



EURONET

ISO 9001: 2015 CERTIFIED



COMPLETE RANGE OF
INDOOR & OUTDOOR LIGHTS



Features:

- Enables outdoor grilling at night.
- Provides increased safety after dark.
- It helps to thwart crime during night.
- Useful during seasons when it gets darker earlier.
- Enables to see how to get from one location to another.
- Helps to create comfortable and communal surroundings.
- Creates a warm welcome when family and guests enter the front door.
- Highlights and adds drama to interesting landscape or architectural features.



TECHNICAL SPECIFICATIONS

ACCESSORIES

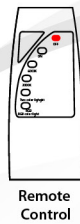

Remote Control



Battery



Screw Accessories

Benefits of Using Energy-Efficient Outdoor Lighting For Your Business

- Enhanced energy efficiency
- Reduced carbon emissions
- Reduced light pollution
- Increased public safety
- Improved Appearance

GENERAL Specifications

Item Name	Solar Garden Light
Light source	LED lamp
Light Type	LED lamp
Solar Panel	2.2W
Cell Type	Li-Battery
Solar Panel	2.2W
Light Source	1w Super Bright LED
Switch	ON/OFF
Working Time	12-20 Hrs
Illumination Time	8h
Voltage	3.6V
Battery Capacity	3.7/2500mAh
Charging Time	6-8 Hrs
IP Grade	IP65
Main Material LampShade	Acrylic
Base	Stainless Steel

Benefits of Installing Outdoor Lighting

Your Home

Lighting your home's structure allows you to extend the beauty of your home in the dark of night when it would otherwise be obscured

Your Lanscaping

Landscape lighting is used to illuminate standout features, such as trees, sculptures or water features, as well as around garden and pathways

Your Safety

A well-planned outdoor lighting scheme should include all the light necessary to move safely around your property at night

Your Security

Criminals are less likely to approach as well-lit home where they can be seen. The more you can eliminate dark corners, the more secure your home will be.

ELECTRIC HANGING LIGHT

www.euronetdxb.com



EURONET

ISO 9001: 2015 CERTIFIED

Features:

- Eco-Friendly
- Long Lifespan
- Energy efficiency
- Low radiated heat
- Directional lighting
- Exceptional colour range
- Instantaneous illumination
- Reliability & Compact in Size
- High brightness and intensity
- Superior Color Rendering Accuracy
- Function in Cold and Hot Temperatures



TECHNICAL SPECIFICATIONS

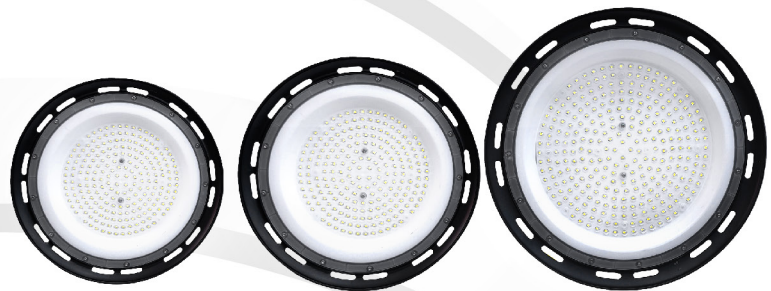

Item No.	Power	LED Source	Input Voltage	Frequency	Withstand voltage	IP	PF	Lumen	RA	Color Temperature	Beam Angle	Lifespan	Dimension (MM)
EU FL 150W	150W	216 PCS-2835	DOB 100-265V	50/60HZ	1500V	IP65	>0.5	105-115 LM/W	>80	6500K	90°	35000 hrs	Φ 310* 83
EU FL 200W	200W	288 PCS-2835	DOB 100-265V	50/60HZ	1500V	IP65	>0.5	105-115 LM/W	>80	6500K	90°	35000 hrs	Φ 377* 83

Item No.	Power	LED Source	Input Voltage	Frequency	Withstand voltage	Surge	IP	PF	Lumen	RA	Color Temperature	Beam Angle	Lifespan	Dimension (MM)
EU HL 100W - G	100W	125 PCS-2835	Non-isolated 100-265V	50/60HZ	1500V	4KV	IP65	>0.5	110-120 LM/W	>80	6500K	90°	35000 hrs	Φ 270* 115
EU HL 150W - G	150W	200 PCS-2835	Non-isolated 100-265V	50/60HZ	1500V	4KV	IP65	>0.5	110-120 LM/W	>80	6500K	90°	35000 hrs	Φ 300* 120
EU HL 200W - G	200W	250 PCS-2835	Non-isolated 100-265V	50/60HZ	1500V	4KV	IP65	>0.5	110-120 LM/W	>80	6500K	90°	35000 hrs	Φ 350* 130



ELECTRIC CEILING LIGHT

www.euronetdxb.com



ISO 9001: 2015 CERTIFIED

Features:

- Good lighting ability
- Power saving, durable
- Variety in color selection
- Environmentally friendly
- Reliability & Compact in Size
- High brightness and intensity
- Superior Color Rendering Accuracy
- Create a luxurious, sophisticated space
- Function in Cold and Hot Temperatures



TECHNICAL SPECIFICATIONS

Item No.	Power	LED Source	Input Voltage	Frequency	Withstand voltage	Surge	IP	PF	Lumen	RA	Color Temperature	Beam Angle	Lifespan	Dimension (MM)
EU ECL - 200W	200W	120*2 PCS-3030	Isolated 100-265V Meanwell Driver	50/60HZ	1500V	6KV	IP66	>0.9	120-130 LM/W	>80	6500K	90°	50000 hrs	410*220*45
EU ECL - 300W	300W	120*3 PCS-3030	Isolated 100-265V Meanwell Driver	50/60HZ	1500V	6KV	IP66	>0.9	120-130 LM/W	>80	6500K	90°	50000 hrs	410*312*45
EU ECL - 500W	500W	120*5 PCS-3030	Isolated 100-265V Meanwell Driver	50/60HZ	1500V	6KV	IP66	>0.9	120-130 LM/W	>80	6500K	90°	50000 hrs	410*508*45
EU ECL - 1000W	1000W	120*10 PCS-3030	Isolated 100-265V Meanwell Driver	50/60HZ	1500V	6KV	IP66	>0.9	120-130 LM/W	>80	6500K	90°	50000 hrs	760*508*45

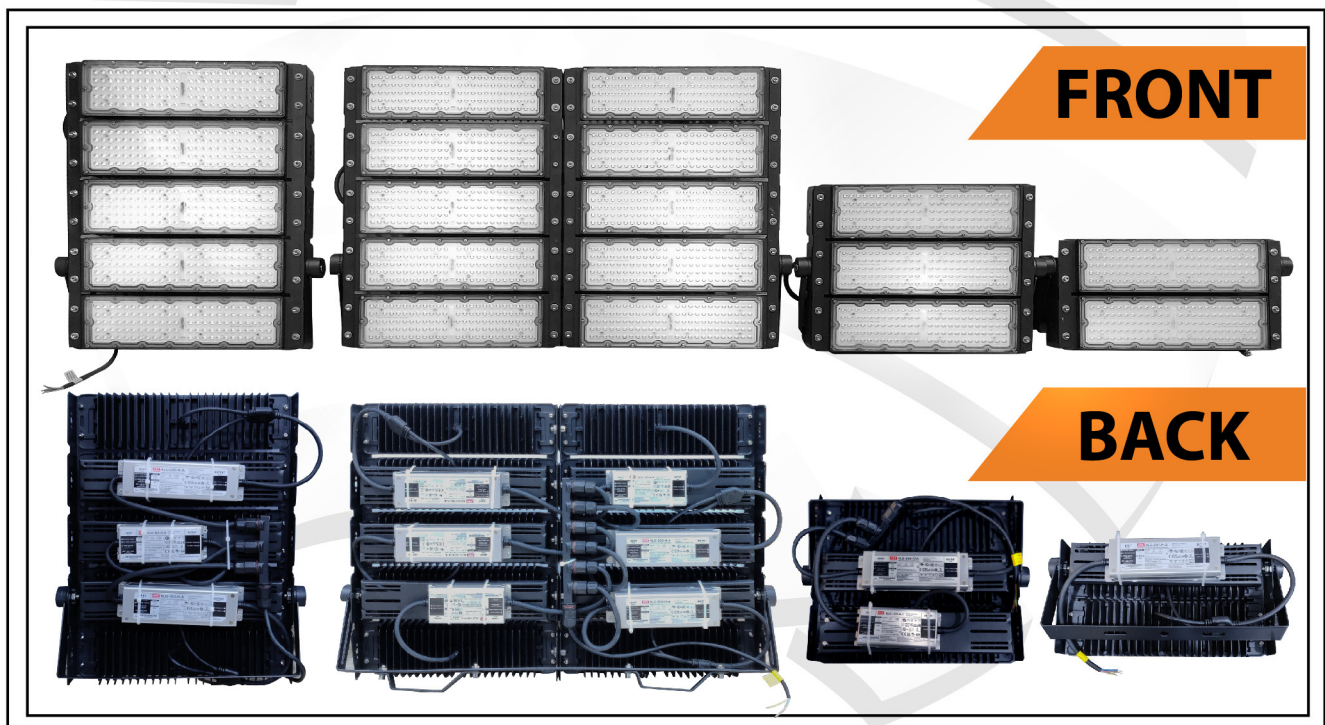



Features:

- Unique optical and lamp design,
- Safe , reliable and excellent brightness.
- Using high quality LED chip with low light decay,
- Low power consumption, high luminous efficiency, and more energy-saving than regular lighting
- Quick switch, no strobe, no radiation and longer product life up to 30000 hours.



TECHNICAL SPECIFICATIONS



MODEL	EURO - E111	EURO - E222	EURO - E333
Watt	10W	5W	10W
Lighting Hours	6H	8H	6H
Time to full Charge	12H	20H	12H
CCT	8000~ 10000K		
Voltage	AC170-240V 50/60Hz		
Battery Capacity	1700mAh, 8V	2500mAh, 8V	1700mAh, 8V
Temperature	From 20°C to + 50°C		

SOLAR PATHWAY LIGHT

www.euronetdxb.com



EURONET

ISO 9001: 2015 CERTIFIED

Model: E-8001

Hammered Metal Lens

Warm White 3000K LED



NO WIRING REQUIRED



NO TOOLS REQUIRED

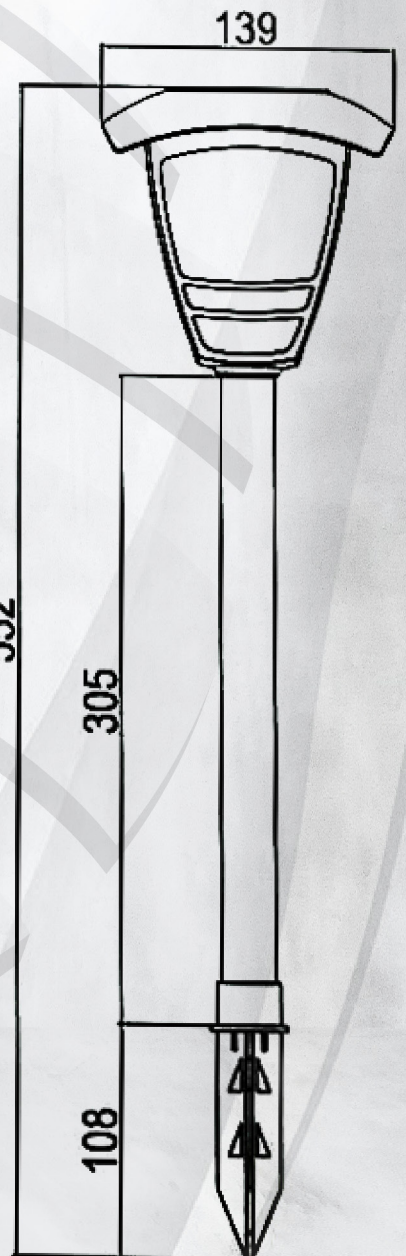

SOLAR PATHWAY LIGHT

www.euronetdxb.com



ISO 9001: 2015 CERTIFIED

Model: E-8002

Hammered Metal Lens

Warm White 3000K LED



NO WIRING REQUIRED



NO TOOLS REQUIRED



SOLAR PATHWAY LIGHT

www.euronetdxb.com



EURONET

ISO 9001: 2015 CERTIFIED

Model: E-8003

Hammered Metal Lens

Warm White 3000K LED



NO WIRING REQUIRED



NO TOOLS REQUIRED

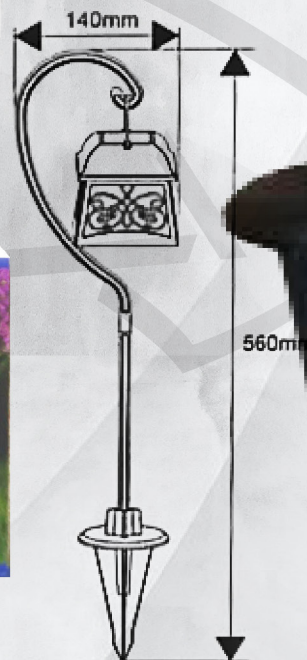

E-8003



SOLAR PATHWAY LIGHT

www.euronetdxb.com



EURONET

ISO 9001: 2015 CERTIFIED

Model: E-8004



Rechargeable Battery Included

1

Years
Limited Warranty

12

LUMENS Light output
(Lumens rated at peak output)

8

HOURS Operating time
on average sunny day charge

3000

Warm White 3000K LED



NO WIRING REQUIRED



NO TOOLS REQUIRED

Hammered Metal Lens

Warm White 3000K LED



NO WIRING REQUIRED



NO TOOLS REQUIRED

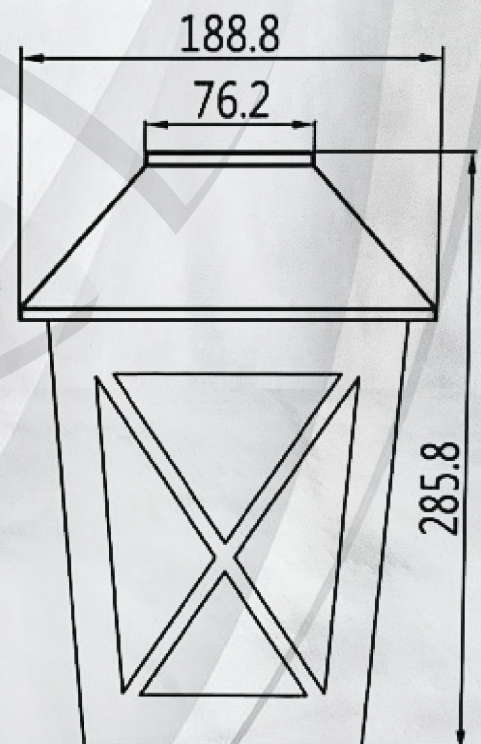

Model: E-8005

Hammered Metal Lens

Warm White 3000K LED



NO WIRING REQUIRED



NO TOOLS REQUIRED

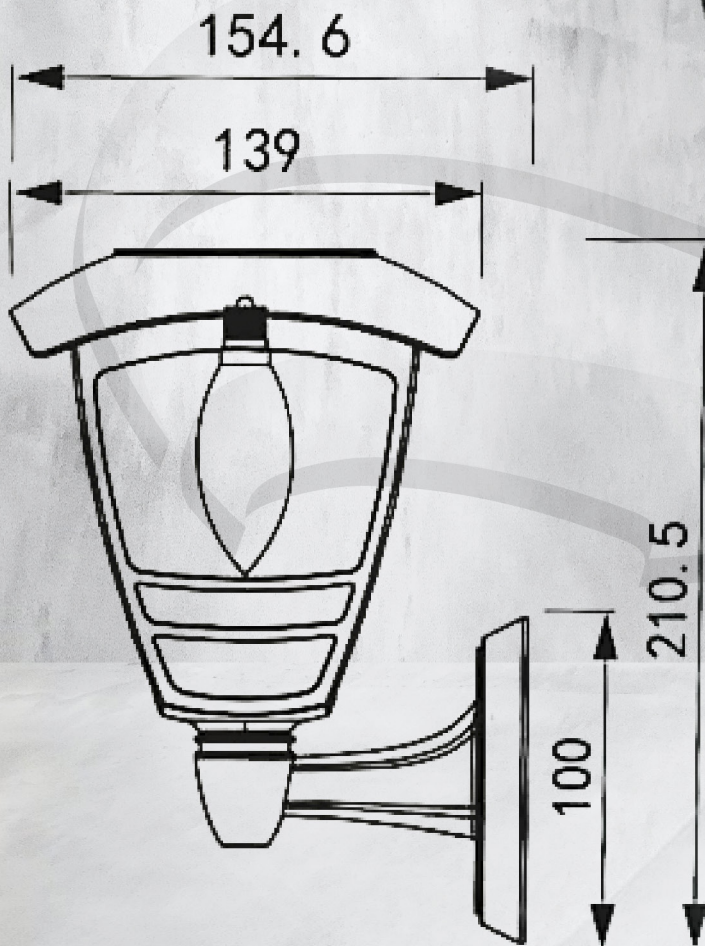

SOLAR PATHWAY LIGHT

www.euronetdxb.com



ISO 9001: 2015 CERTIFIED

Model: E-8006



Hammered Matel Lens

Warm White 3000K LED



NO WIRING REQUIRED



NO TOOLS REQUIRED

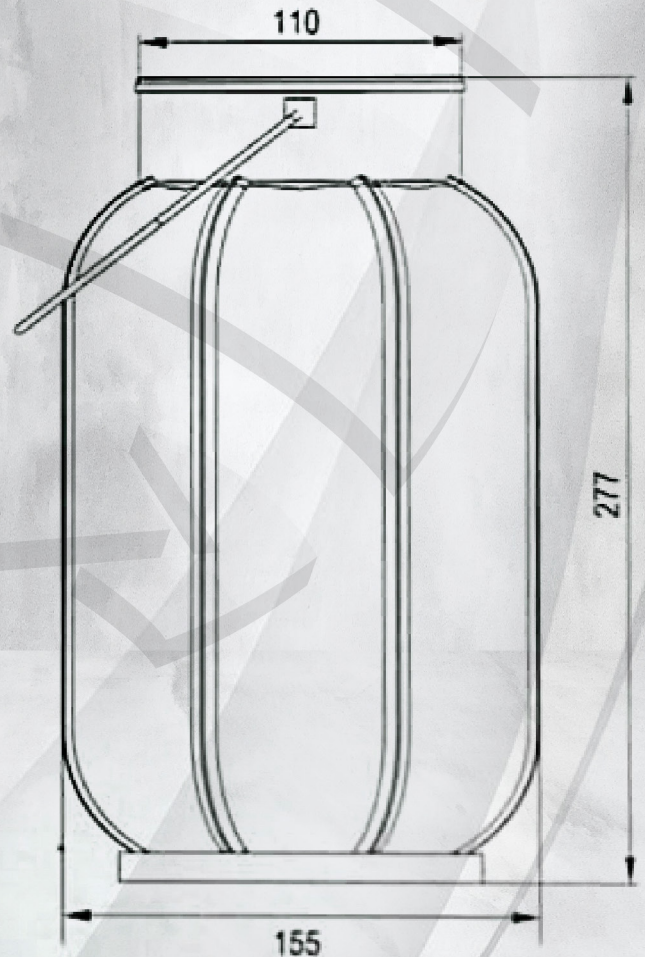

SOLAR PATHWAY LIGHT

www.euronetdxb.com



EURONET

ISO 9001: 2015 CERTIFIED

Model: E-8007



Hammered Metal Lens

Warm White 3000K LED



NO WIRING REQUIRED



NO TOOLS REQUIRED





Model: 4330s / 4331s

Product's Characteristics:

1. Built in with capacity 800mah rechargeable maintenance free-aid battery.
2. The battery has long life. and the numbers of discharge of the battery is up to 250 times
3. Use pcs 1W high LED light and 8 pcs 0.3W LED which has long life. low power consumption and white light.
4. Solar panel: 0.2W

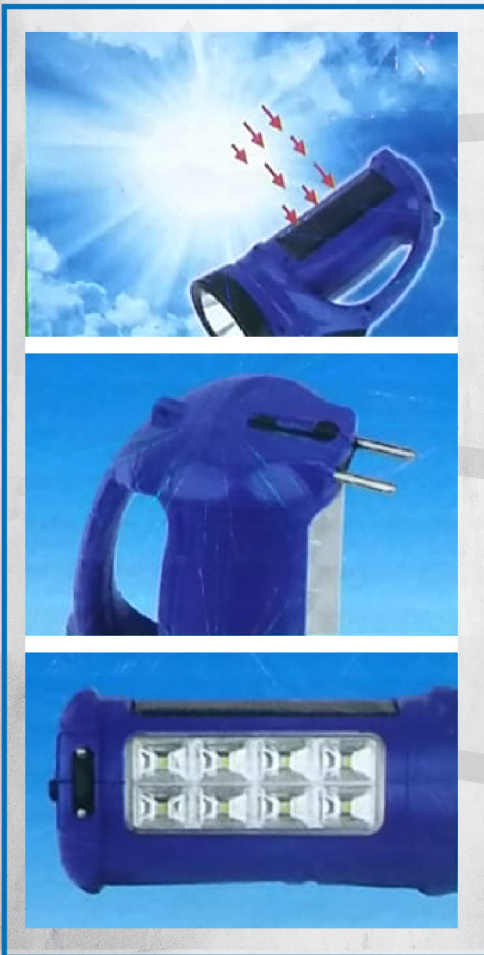

SOLAR LED BULB

www.euronetdxb.com



ISO 9001: 2015 CERTIFIED

Model: 5W, 7W, 9W

Features:

- Dimmable Led Bulb
- Flicker-free lighting
- Low power consumption
- Led Light With An A+ Energy Label
- Connects to any regular bulb holder
- 4 times longer life compared to normal bulb
- LED bulbs use 80% less energy than normal bulbs



Model: 9W , 18 W

High Brightness

Soft Light

High Color
Rendering

Features:

- High level of brightne
- Low consumption of energy
- Low generation of heat



Certificate

Standard **ISO 9001:2015**

Certificate Registr. No. **01 100 2122578/01**

Organization:



Smart Euronet Electronics LLC

Shop No 2&3, Al Shams Building, Naif Satellite Market,
Behind Naif Park, Deira,
Dubai,
United Arab Emirates

Site:

c/o **Smart Euronet Electronics LLC**

Shop No 2&3, Al Shams Building, Naif Satellite Market,
Behind Naif Park, Deira,
Dubai,
United Arab Emirates

Scope:

Trading of Refrigerators, Washing machines & Household
Electrical Appliances, Satellite receiving Equipment, Solar Energy
Systems & Components, Security control & Alarm Equipment,
Electrical & Electronic Appliances Spare parts

Validity:

Proof has been furnished by means of an audit that the
requirements of ISO 9001:2015 are met.

The certificate is valid in conjunction with the main certificate 01
100 2122578 from 2021-07-26 until 2024-07-25.

2021-08-03

A handwritten signature in blue ink, appearing to read "K. K. K.", positioned above a horizontal line.

TÜV Rheinland Cert GmbH
Am Grauen Stein · 51105 Köln



SMART EURONET ELECTRONICS LLC

📍 Naif Electronic Market, Deira, Dubai - United Arab Emirates

🌐 www.euronetdxb.com ✉ euronetdxb@gmail.com 📷 (@smarteuronet) 📘

